

TRUMP

PRODUCT FORMS

• **TRUMP** Wall / Ceiling Installation

S1

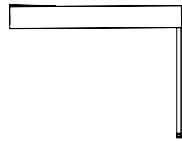

• **TRUMP** Freestanding

S2

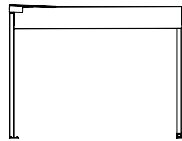

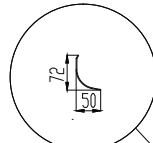
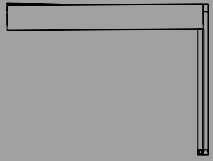

ALM.KSB.009

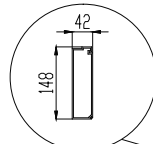

ALM.PRF.059

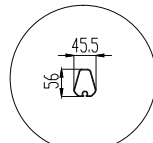

ALM.PRF.011

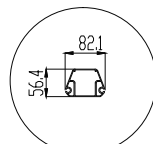

ALM.PRF.010

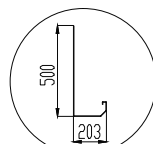

ALM.DRE.004

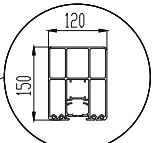
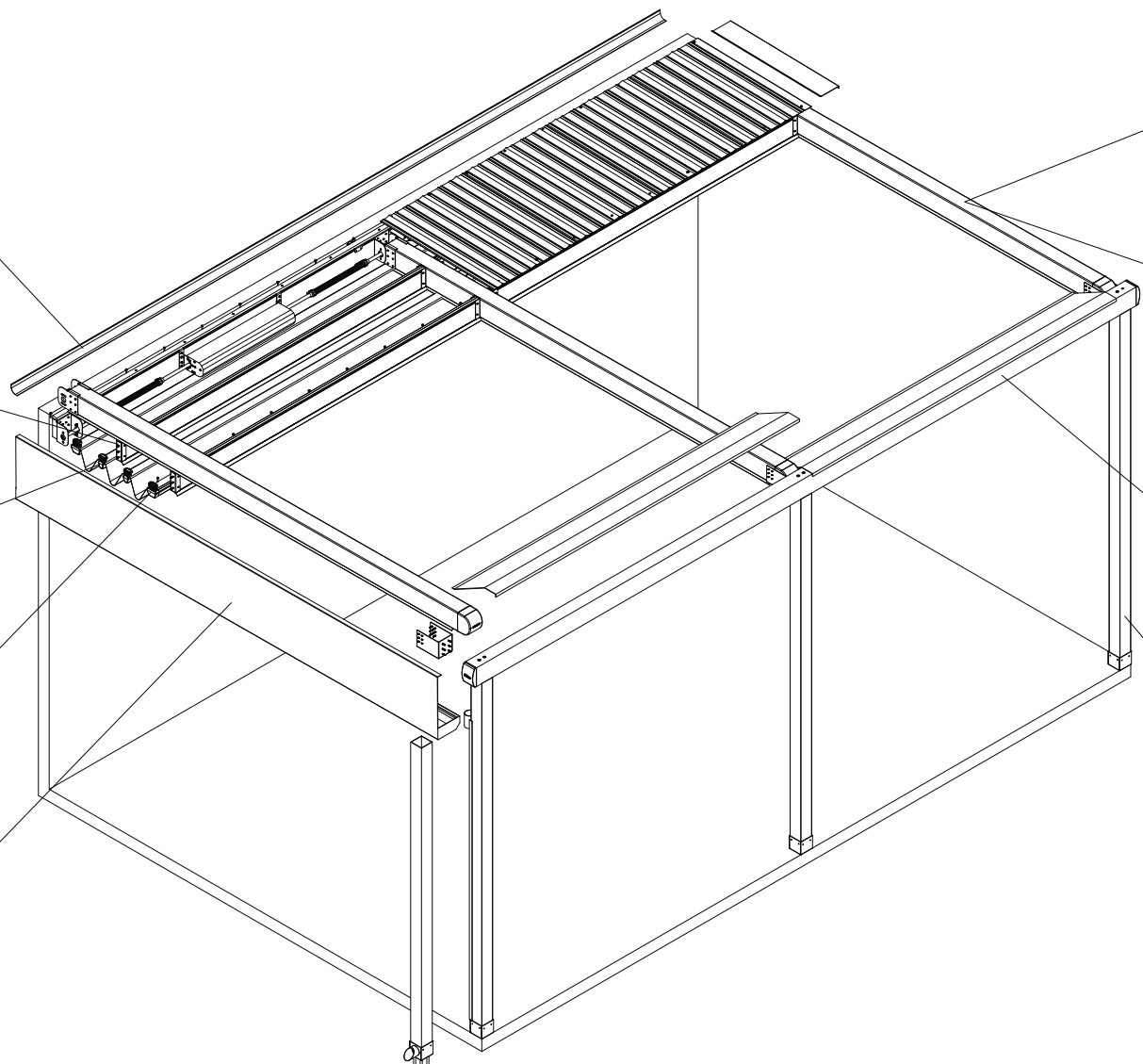

ALM.PRF.109

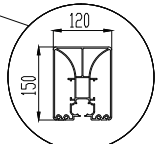

ALM.PRF.061

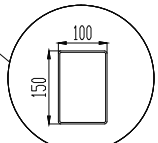

ALM.PRF.099

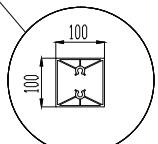

ALM.PRF.001

TECHNICAL FEATURES

MAXIMUM DIMENSIONS

	WIDTH	PROJECTION
2 RAILS	450 cm	800 cm
3 RAILS	900 cm	800 cm
4 RAILS	1300 cm	800 cm

DOWN PIPE & GUTTER CALCULATION

Type	Max. m ²	Max. Gutter Length
Standard (ø 60mm)	39 m ² /pcs	800 cm

WIND RESISTANCE

		WIDTH (cm)																		
		450	500	550	600	650	700	750	800	850	900	950	1000	1050	1100	1150	1200	1250	1300	
PROJECTION (cm)	400	11	11	11	11	11	11	11	11	11	11	11	11	11	11	11	11	11	11	
	450	11	11	11	11	11	11	11	11	11	11	11	11	11	11	11	11	11	11	
	500	11	11	11	11	11	11	11	11	11	11	11	11	11	11	11	11	11	11	
	550	11	11	11	11	11	11	11	11	11	11	11	11	11	11	11	11	11	11	
	600	11	11	11	11	11	11	11	11	11	11	11	11	11	11	11	11	11	11	
	650	11	11	11	11	11	11	11	11	11	11	11	11	11	11	11	11	11	11	
	700	11	11	11	11	11	11	11	11	11	11	11	11	11	11	11	11	11	11	
	750	11	11	11	11	11	11	11	11	10	10	10	11	11	11	11	11	10	10	10
	800	11	11	11	11	11	10	10	10	10	10	11	11	10	10	10	10	10	10	10

*The values are given according to the Beaufort scale.

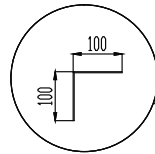
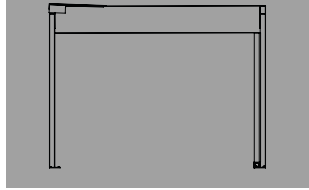

ALM.KSB.016

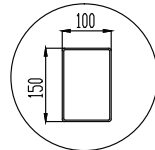

ALM.PRF.003

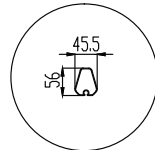

ALM.PRF.011

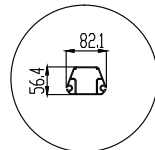

ALM.PRF.010

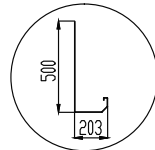

ALM.DRE.004

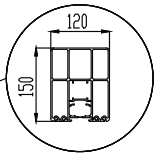
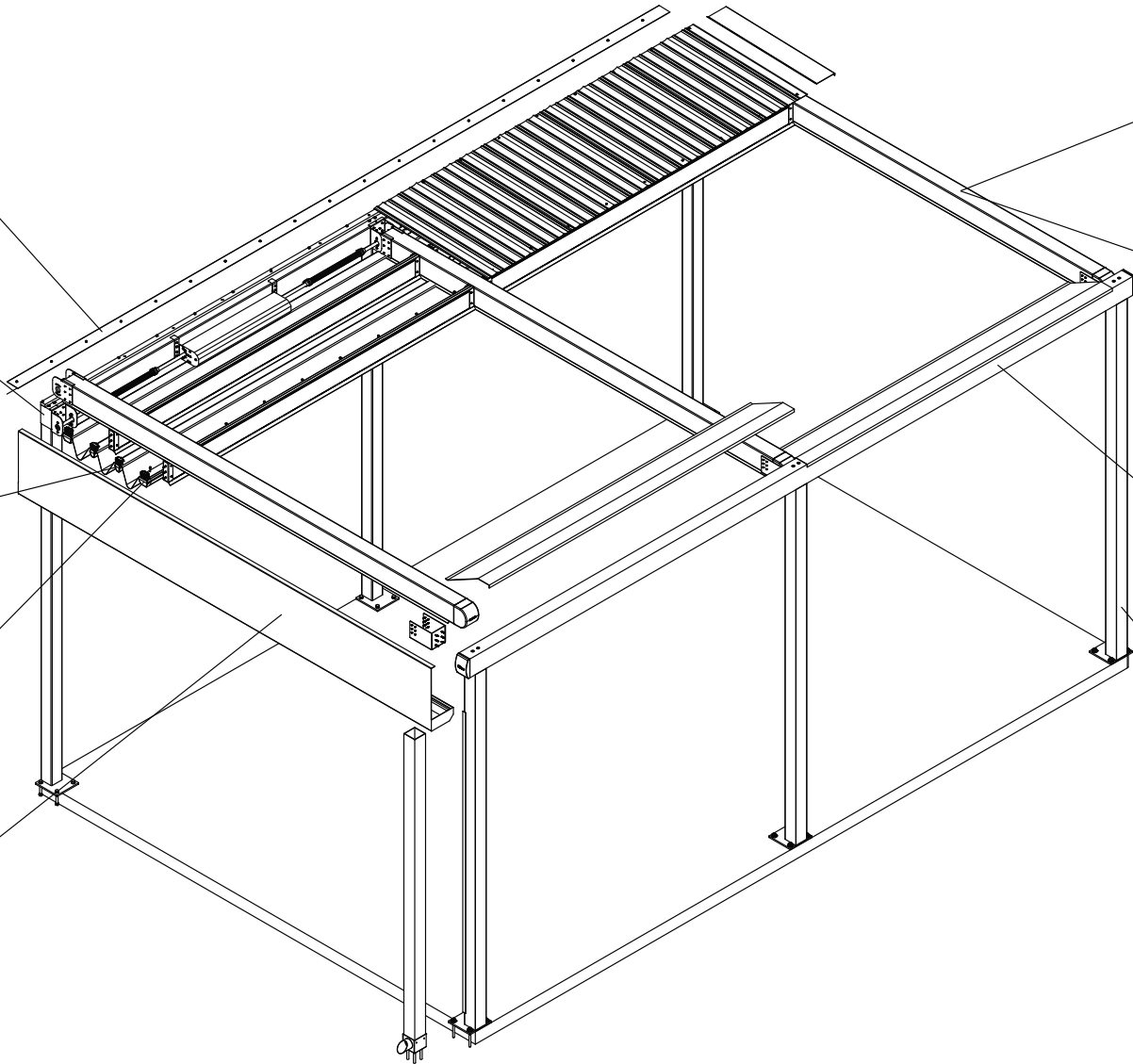

ALM.PRF.109

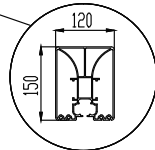

ALM.PRF.061

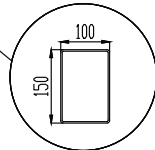

ALM.PRF.099

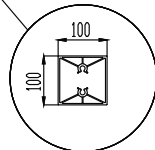

ALM.PRF.001

TECHNICAL FEATURES

MAXIMUM DIMENSIONS

	WIDTH	PROJECTION
2 RAILS	450 cm	800 cm
3 RAILS	900 cm	800 cm
4 RAILS	1300 cm	800 cm

DOWN PIPE & GUTTER CALCULATION

Type	Max. m ²	Max. Gutter Length
Standard (ø 60mm)	39 m ² /pcs	800 cm

WIND RESISTANCE

		WIDTH (cm)																	
		450	500	550	600	650	700	750	800	850	900	950	1000	1050	1100	1150	1200	1250	1300
PROJECTION (cm)	400	11	11	11	11	11	11	11	11	11	11	11	11	11	11	11	11	11	11
	450	11	11	11	11	11	11	11	11	11	11	11	11	11	11	11	11	11	11
	500	11	11	11	11	11	11	11	11	11	11	11	11	11	11	11	11	11	11
	550	11	11	11	11	11	11	11	11	11	11	11	11	11	11	11	11	11	11
	600	11	11	11	11	11	11	11	11	11	11	11	11	11	11	11	11	11	11
	650	11	11	11	11	11	11	11	11	11	11	11	11	11	11	11	11	11	11
	700	11	11	11	11	11	11	11	11	11	11	11	11	11	11	11	11	11	11
	750	11	11	11	11	11	11	11	11	10	10	10	11	11	11	11	11	10	10
	800	11	11	11	11	11	10	10	10	10	10	11	11	10	10	10	10	10	10

*The values are given according to the Beaufort scale.